

# YAMAHA AX-390

*Natural Sound Stereo Integrated Amplifier*

*Préampli/ampli de puissance stéréo de la série "Natural Sound"*

*Natural Sound Stereo-Verstärker*

*Natural Sound Integrerad Stereo Förstärkare*

*Amplificatore integrato stereo a Suono Naturale*

*Amplificador integrado estéreo de Sonido Natural*

*Natural Sound Geïntegreerde Stereo Versterker*

OWNER'S MANUAL  
MODE D'EMPLOI  
BEDIENUNGSANLEITUNG  
BRUKSANVISNING  
MANUALE DI ISTRUZIONI  
MANUAL DE INSTRUCCIONES  
GEBRUIKSAANWIJZING

**SUPPLIED ACCESSORIES**  
**ACCESSOIRES FOURNIS**  
**MITGELIEFERTE ZUBEHÖRTEILE**  
**MEDFÖLJANDE TILLBEHÖR**  
**ACCESSORI IN DOTAZIONE**  
**ACCESORIOS INCLUIDOS**  
**BIJGELEVERDE ACCESSOIRES**

- After unpacking, check that the following parts are included.
- Après le déballage, vérifier que les pièces suivantes sont incluses.
- Nach dem Auspacken überprüfen, ob die folgenden Teile vorhanden sind.
- Kontrollera efter det apparaten packats upp att följande delar finns med.
- Verificare che tutte le parti seguenti siano contenute nell'imballaggio dell'apparecchio.
- Desembale el aparato y verificar que los siguientes accesorios están en la caja.
- Controleer na het uitpakken of de volgende onderdelen voorhanden zijn.

- Remote Control Transmitter
- Emetteur de télécommande
- Fernbedienungsgeber
- Fjärrkontrollsändare
- Telecomando
- Transmisor del control remoto
- Afstandbediening

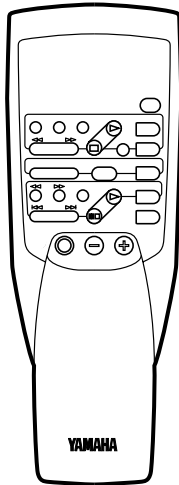

- Batteries (size AA, R6, UM-3)
- Piles (taille AA, R6, UM-3)
- Batterien (Größe AA, R6, UM-3)
- Batterier (storlek AA, R6, UM-3)
- Batterie (dimensioni AA, R6, UM-3)
- Pilas (tamaño AA, R6, UM-3)
- Batterijen (maat AA, R6, UM-3)

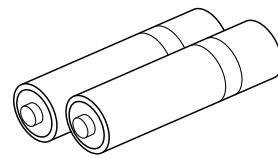

This product complies with the radio frequency interference requirements of the Council Directive 82/499/EEC and/or 87/308/EEC.

Cet appareil est conforme aux prescriptions de la directive communautaire 87/308/CEE.

Diese Geräte entsprechen der EG-Richtlinie 82/499/EWG und/oder 87/308/EWG.

Detta apparat överholder det gældende EF-direktiv vedrørende radiostøj.

Questo apparecchio è conforme al D.M.13 aprile 1989 (Direttiva CEE/87/308) sulla soppressione dei radiodisturbi.

Este producto está de acuerdo con los requisitos sobre interferencias de radio frecuencia fijados por el Consejo Directivo 87/308 CEE.

Dit product voldoet aan de EEG normen betreffende radio-frekwentie storingen 82/499/EEG en/of 87/308/EEG.

**For U.K. customers**

If the socket outlets in the home are not suitable for the plug supplied with this appliance, it should be cut off and an appropriate 3 pin plug fitted. For details, refer to the instructions described below.

**Note:** The plug severed from the mains lead must be destroyed, as a plug with bared flexible cord is hazardous if engaged in a live socket outlet.

**Special Instructions for U.K. Model**

**IMPORTANT**

THE WIRES IN THE MAINS LEAD ARE COLOURED IN ACCORDANCE WITH THE FOLLOWING CODE:

Blue: NEUTRAL  
 Brown: LIVE

As the colours of the wires in the mains lead of this apparatus may not correspond with the coloured markings identifying the terminals in your plug, proceed as follows:

The wire which is coloured BLUE must be connected to the terminal which is marked with the letter N or coloured BLACK. The wire which is coloured BROWN must be connected to the terminal which is marked with the letter L or coloured RED. Make sure that neither core is connected to the earth terminal of the three pin plug.

## FEATURES

- **60W + 60W (8Ω) RMS Output Power, 0.04% THD, 20–20,000 Hz**
- **High Dynamic Power, Low Impedance Drive Capability**
- **Continuously Variable Loudness Control**
- **CD DIRECT AMP Switch to Reproduce the Purest CD Sound**
- **Remote Control Capability**

## CONTENTS

Supplied Accessories .....	2
Caution .....	3
Controls and Their Functions .....	4
Connections .....	6
Basic Operations .....	8
Notes about the Remote Control Transmitter.....	11
Troubleshooting .....	12
Specifications .....	13

## CAUTION: READ THIS BEFORE OPERATING YOUR UNIT.

1. To assure the finest performance, please read this manual carefully. Keep it in a safe place for future reference.
2. Install this unit in a cool, dry, clean place – away from windows, heat sources, sources of excessive vibration, dust, moisture and cold. Avoid sources of humming (transformers, motors). To prevent fire or electrical shock, do not expose the unit to rain or water.
3. Never open the cabinet. If something drops into the set, contact your dealer.
4. Do not use force on switches, controls or connection wires. When moving the unit, first disconnect the power plug and the wires connected to other equipment. Never pull the wires themselves.
5. The openings on the cabinet assure proper ventilation of the unit. If these openings are obstructed, the temperature inside the cabinet will rise rapidly. Therefore, avoid placing objects against these openings, and install the unit in well-ventilated condition. Make sure to allow a space of at least 10 cm behind, on the both sides and above the top panel of the unit. Otherwise it may not only damage the unit, but also cause fire.
6. Always set the VOLUME control to “– ∞” before starting the audio source play. Increase the volume gradually to an appropriate level after playback has been started.
7. Do not attempt to clean the unit with chemical solvents; this might damage the finish. Use a clean, dry cloth.
8. Be sure to read the “TROUBLESHOOTING” section regarding common operating errors before concluding that the unit is faulty.
9. When not planning to use this unit for long periods of time (ie., vacation, etc.), disconnect the AC power plug from the wall outlet.
10. To prevent lightning damage, disconnect the AC power plug and disconnect the antenna cable when there is an electrical storm.
11. Grounding or polarization – Precautions should be taken so that the grounding or polarization of an appliance is not defeated.
12. AC outlet  
Do not connect audio equipment to the AC outlet on the rear panel if that equipment requires more power than the outlet is rated to provide.
13. **Voltage Selector (General Model only)**  
**The voltage selector on the rear panel of this unit must be set for your local main voltage BEFORE plugging into the AC main supply.**  
**Voltages are 110/120/220/240V AC, 50/60 Hz.**

### IMPORTANT

Please record the serial number of this unit in the space below.

Serial No.:

The serial number is located on the rear of the unit. Retain this Owner's Manual in a safe place for future reference.

### WARNING

TO REDUCE THE RISK OF FIRE OR ELECTRIC SHOCK, DO NOT EXPOSE THIS UNIT TO RAIN OR MOISTURE.

The apparatus is not disconnected from the AC power source as long as it is connected to the wall outlet, even if the apparatus itself is turned off.

# CONTROLS AND THEIR FUNCTIONS

## FRONT PANEL

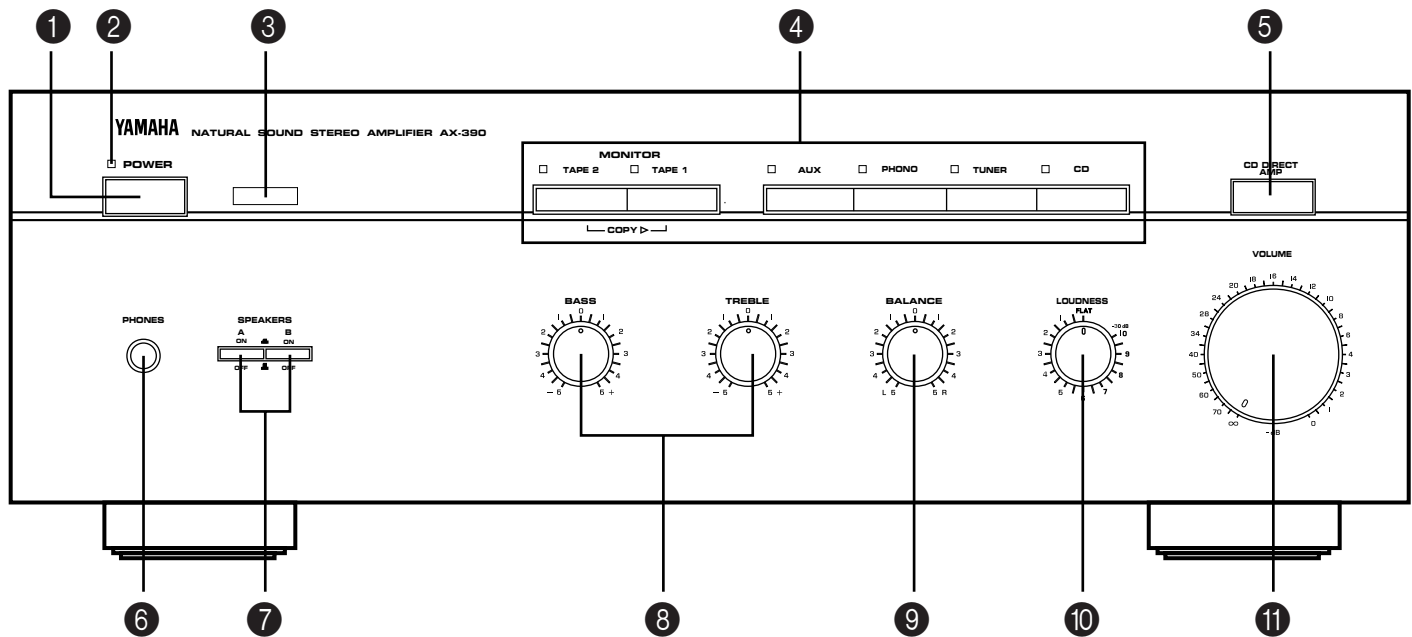

### 1 POWER switch

Press this switch to switch the power on. Press it again to switch the power off.

\* Standby mode <Europe and U.K. models only>

While the power is on, pressing the **POWER** key on the remote control transmitter switches the unit to the standby mode. (In this mode, the power indicator is half illuminated.)

### 2 Power indicator

Lights up while the power is on.

### 3 Remote control sensor

Receives signals from the remote control transmitter.

### 4 Input selector buttons and indicators

Select a program source to listen to. The indicator above the selected button (source) will light up.

### 5 CD DIRECT AMP switch

Press this switch inward to listen to a CD source in the purest sound. (Refer to page 10 for details.)

### 6 PHONES jack

When you listen with headphones, connect the headphones to the **PHONES** jack. When listening with headphones privately, set both the **SPEAKERS A** and **B** switches to the **OFF** position.

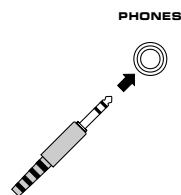

### 7 SPEAKERS switches

Set the switch **A** or **B** (or both **A** and **B**) for the speaker system (connected to this unit) you will use to the **ON** position. Set the switch for the speaker system you will not use to the **OFF** position.

### 8 Tone controls

#### BASS

Used to increase or decrease the low frequency response. The 0 position produces flat response.

#### TREBLE

Used to increase or decrease the high frequency response. The 0 position produces flat response.

### 9 BALANCE control

Adjusts the balance of the output volume to the left and right speakers to compensate for sound imbalance caused by speaker location or listening room conditions.

### 10 Continuously variable LOUDNESS control

Used to compensate for the human ears' loss of sensitivity to high and low-frequency ranges at low volume.

### 11 VOLUME control

Used to raise or lower the volume level.

## REMOTE CONTROL TRANSMITTER

The remote control transmitter provided with this unit is designed to control all the most commonly used functions of the unit. If the CD player, tuner and tape deck connected to this unit are YAMAHA components designed for remote control compatibility, then this remote control transmitter will also control various functions of each component.

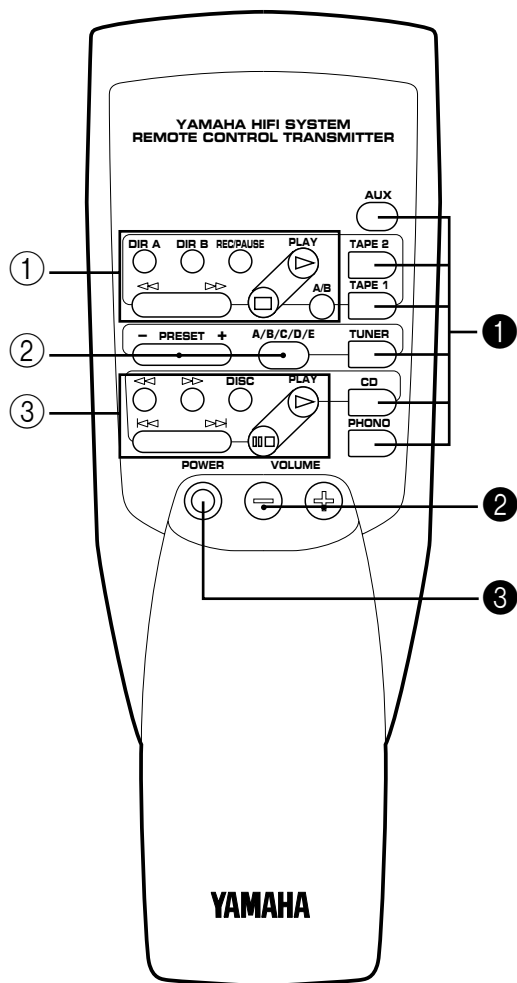

### For Control of This Unit

#### ① Input selector keys

Selects input source.

#### ② VOLUME +/- keys

Turns the volume level up/down.

#### ③ POWER key

Turns the power on/off.

\* <Europe and U.K. models only>

While the power is on, pressing the **POWER** key on the remote control transmitter switches the unit from the power-on mode to the standby mode, and vice versa. (In the standby mode, the power indicator on the front panel is half illuminated.)

### For Other Component Control

Identify the remote control transmitter keys with your component's keys. If these keys are identical, their functions will be the same. On each key function, refer to the corresponding instruction on your component's manual.

#### ① Tape deck keys

Controls tape deck.

- \* **DIR A, B** and **A/B** are applicable only to double cassette tape deck.
- \* For a single cassette deck with automatic reverse function, pressing **DIR A** will reverse the direction of tape running.

#### ② Tuner keys

Controls tuner.

**+**: Selects higher preset station number.

**-**: Selects lower preset station number.

**A/B/C/D/E** Selects the group (A – E) of preset station numbers.

#### ③ CD player keys

Controls compact disc player.

- \* **DISC** is applicable only to compact disc changer.

# CONNECTIONS

Before attempting to make any connections to or from this unit, be sure to first switch OFF the power to this unit and to any other components to which connections are being made.

## CONNECTIONS WITH OTHER COMPONENTS

When making connections between this unit and other components, be sure all connections are made correctly, that is to say L (left) to L, R (right) to R, “+” to “+” and “-” to “-”. Also, refer to the owner’s manual for each component to be connected to this unit.

- \* If you have YAMAHA components numbered as 1, 2, 3, etc. on the rear panel, connections can be made easily by making sure to connect the output (or input) terminals of each component to the same-numbered terminals of this unit.

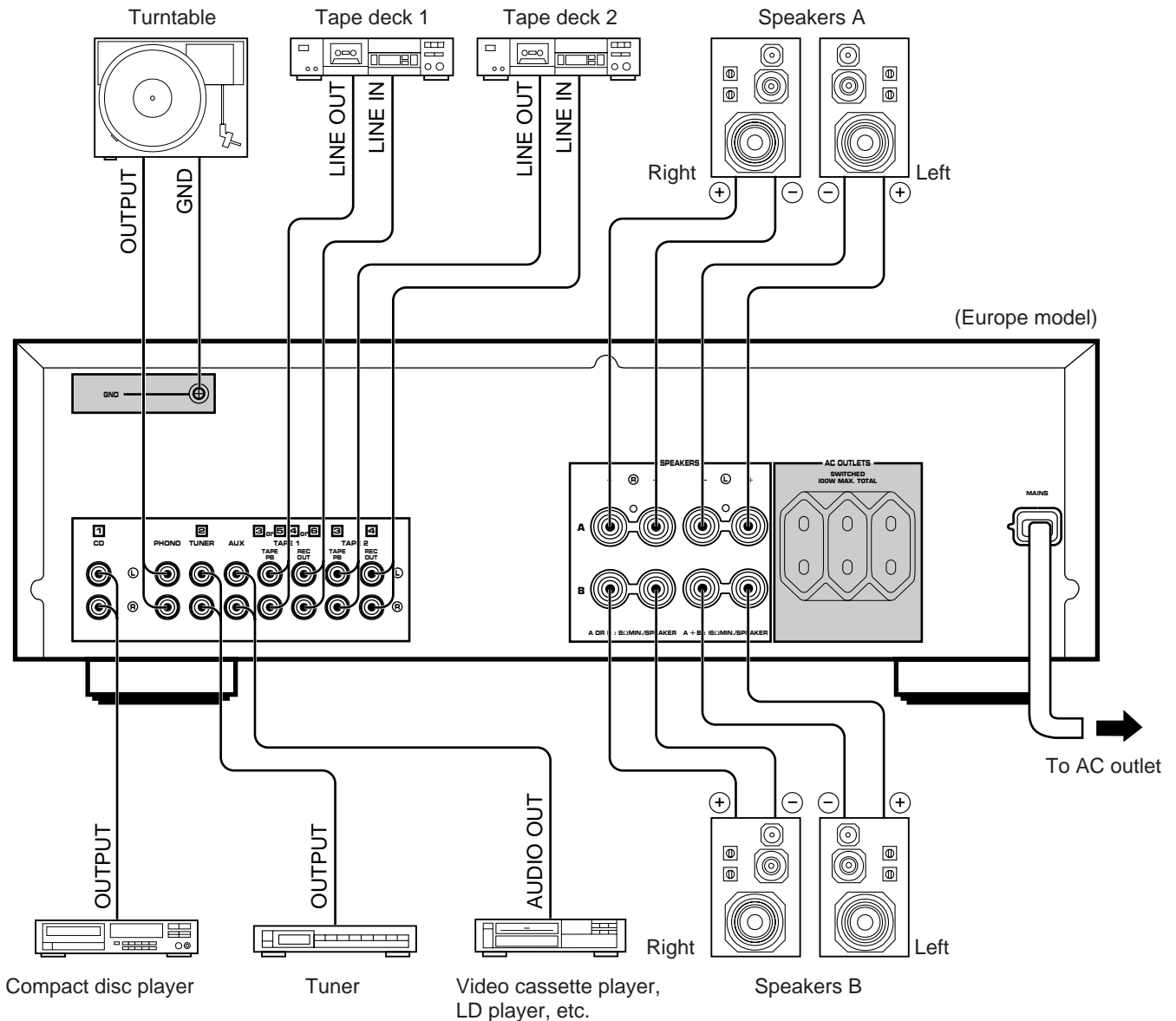

 : Refer to “**ABOUT THE ACCESSORY TERMINALS**” on page 7.

## CONNECTING SPEAKERS

Connect the **SPEAKERS** terminals to your speakers with wire of the proper gauge, cut as short as possible. If the connections are faulty, no sound will be heard from the speakers. Make sure that the polarity of the speaker wires is correct, that is, + and – markings are observed. If these wires are reversed, the sound will be unnatural and will lack bass.

**Do not let the bare speaker wires touch each other and do not let them touch the metal parts of this unit as this could damage this unit and/or speakers.**

### How to Connect:

Red: positive (+)  
Black: negative (-)

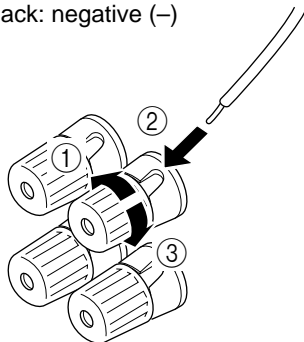

- ① Unscrew the knob.
- ② Insert the bare wire.  
[Remove approx. 5mm (1/4") insulation from the speaker wires.]
- ③ Tighten the knob and secure the wire.

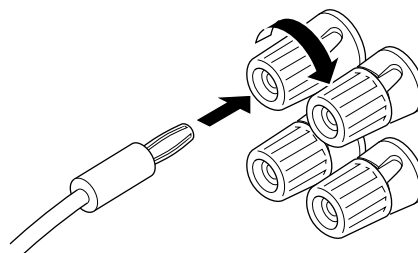

### Notes

- One or two speaker systems can be connected to this unit. If you connect only one speaker system, connect it to either the **SPEAKERS A** or **B** terminals.
- Use speakers with the specified impedance shown on the rear of this unit.
- **<General model only>**  
Banana Plug connections are also possible. Simply insert the Banana Plug connector into the corresponding terminal.

## ABOUT THE ACCESSORY TERMINALS

### AC OUTLET(S) (SWITCHED)

(Europe and General models) ..... 3 SWITCHED OUTLETS  
(U.K. model) ..... 1 SWITCHED OUTLET  
Use these to connect the power cords from your components to this unit.

The power to the **SWITCHED** outlets is controlled by this unit's **POWER** switch or the provided remote control transmitter's **POWER** key. These outlets will supply power to any component whenever this unit is turned on.

The maximum power (total power consumption of components) that can be connected to the **SWITCHED AC OUTLET(S)** is 100 watts.

### GND terminal (For turntable use)

Connecting the ground wire of the turntable to this terminal will normally minimize hum, but in some cases better results may be obtained with the ground wire disconnected.

# BASIC OPERATIONS

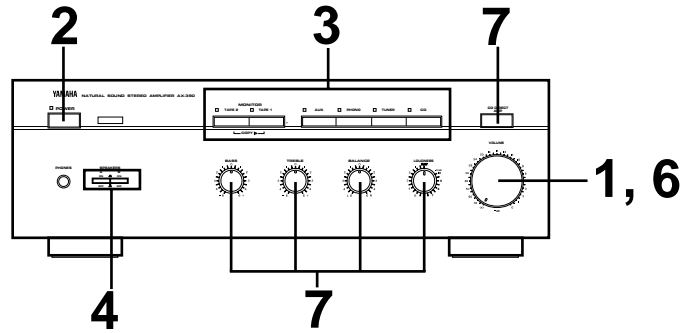

## TO PLAY A SOURCE

**1**

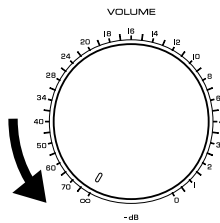

Set to the "∞" position.

**2**

Turn the power on.

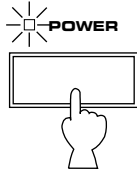

**3**

Select the desired input source by pressing the corresponding input selector button.

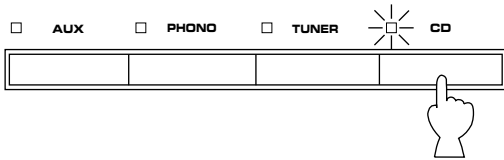

- \* The indicator above the selected button (source) will light up.
- \* Note that pressing on each input selector button selects the source which is connected to the corresponding input terminals on the rear panel.

**4**

Select the speakers to be used.

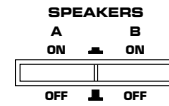

- \* If you use two speaker systems, press both the A and B switches.

**5**

Play the source.

**6**

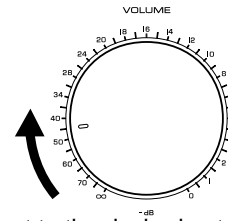

Adjust to the desired output level.

**7**

If desired, adjust the **BASS, TREBLE, BALANCE** and **LOUDNESS** controls, etc. (refer to page 10).

### Notes

- If you select **AUX, PHONO, TUNER** or **CD**, be sure that **TAPE 1** and/or **TAPE 2** are not being selected.
- If you select **TAPE 1** and **TAPE 2** at the same time, the result will be the sound from the tape deck 1.
- For **TAPE 1** and **TAPE 2**, whenever the button is pressed, the corresponding input source is selected or canceled alternately.

### To turn off the power

Press the **POWER** switch again.



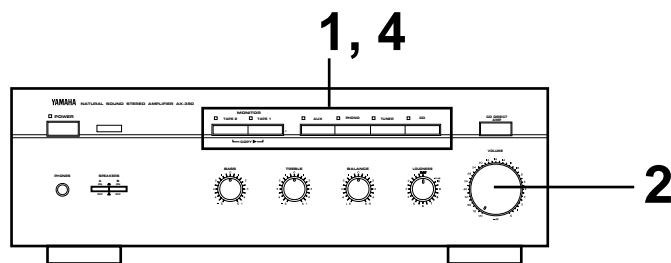

## TO RECORD A SOURCE TO TAPE

- 1** Select the source to be recorded.

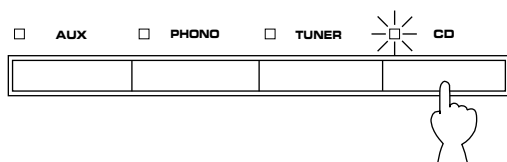

- \* To dub from tape to tape, refer to the “Notes” shown at right.
- \* When you select **AUX, PHONO, TUNER** or **CD**, make sure that neither **TAPE 1** nor **TAPE 2** is also selected.

- 2** Play the source and then turn the **VOLUME** control up to confirm the input source.

- 3** Begin recording on the tape deck.

- 4** To monitor the audio signals being recorded, press the input selector button for the tape deck being used to make the recording.

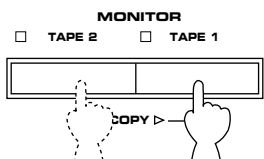

### Notes

- **VOLUME, BASS, TREBLE, BALANCE, LOUDNESS** controls and **CD DIRECT AMP** switch settings have no effect on the material being recorded.
- To dub from tape to tape, select **TAPE 2** by pressing it. Only the following method of dubbing can be made by using this unit.

SOURCE	RECORDER
Tape deck connected to the TAPE 2 terminals.	→ Tape deck connected to the TAPE 1 terminals.

## Selecting the SPEAKER system

Because one or two speaker systems can be connected to this unit, the **SPEAKERS** switches allow you to select speaker system **A** or **B**, or both at once.

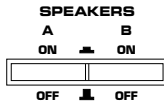

## Adjusting the BALANCE control

Adjust the balance of the output volume to the left and right speakers to compensate for sound imbalance caused by speaker location or listening room conditions.



## Adjusting the BASS and TREBLE controls

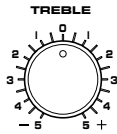
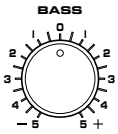

**BASS** : Turn this clockwise to increase (or counter-clockwise to decrease) the low frequency response.

**TREBLE** : Turn this clockwise to increase (or counter-clockwise to decrease) the high frequency response.

## Using the CD DIRECT AMP switch

You can enjoy the purest possible CD sound from your CD player by pressing this switch inward. By doing so, CD's input signals are sent to the built-in amplifier special for CD directly bypassing the input selector buttons, the **BASS**, **TREBLE**, **BALANCE** and **LOUDNESS** controls, and then sent to the power amplifier. This signal routing reproduces the purest CD sound eliminating any alterations to the CD signals.

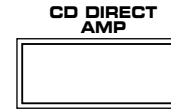

## Adjusting the continuously variable LOUDNESS control

This control provides compensation for the human ears' loss of sensitivity to high and low-frequency ranges at low volume. This control is adjustable to retain full tonal range at any volume level.

1

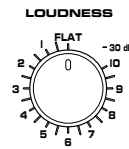

Set to the "FLAT" position.

2

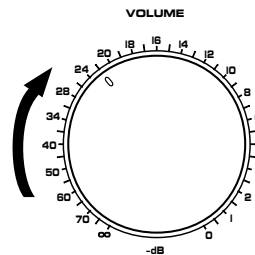

Set to the loudest listening level that you would listen to.

3

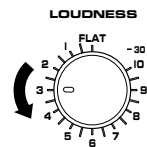

Turn until the desired volume is gained.

# NOTES ABOUT THE REMOTE CONTROL TRANSMITTER

## Battery installation

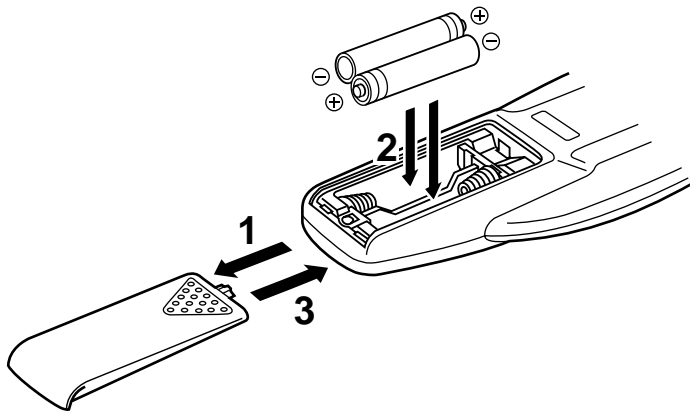

## Battery replacement

If you find that the remote control transmitter must be used closer to the main unit, the batteries are weak. Replace both batteries with new ones.

### Notes

- Use only AA, R6, UM-3 batteries for replacement.
- Be sure the polarities are correct. (See the illustration inside the battery compartment.)
- Remove the batteries if the remote control transmitter will not be used for an extended period of time.
- If batteries leak, dispose of them immediately. Avoid touching the leaked material or letting it come in contact with clothing, etc. Clean the battery compartment thoroughly before installing new batteries.

## Remote control transmitter operation range

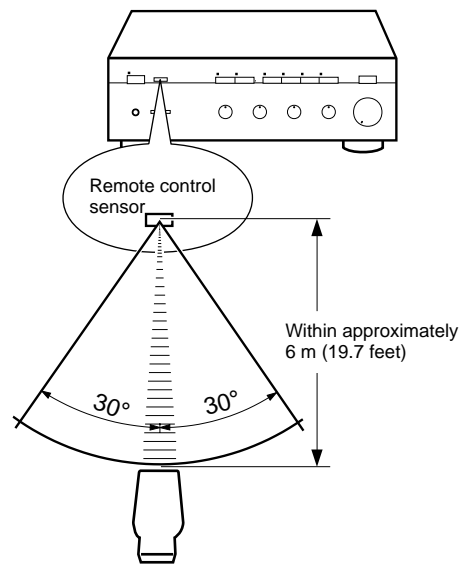

### Notes

- There should be no large obstacles between the remote control transmitter and the main unit.
- If the remote control sensor is directly illuminated by strong lighting (especially an inverter type of fluorescent lamp etc.), it might cause the remote control transmitter not to work correctly. In this case, reposition the main unit to avoid direct lighting.

# TROUBLESHOOTING

If the unit fails to operate normally, check the following points to determine whether the fault can be corrected by the simple measures suggested. If it cannot be corrected, or if the fault is not listed in the SYMPTOM column, disconnect the power cord and contact your authorized YAMAHA dealer or service center for help.

SYMPTOM	CAUSE	REMEDY
<b>The unit fails to turn on when the POWER switch is pressed.</b>	Power cord is not plugged in or is not completely inserted.	Firmly plug in the power cord.
<b>No sound.</b>	Incorrect output cord connections.	Connect the cords properly. If the problem persists, the cords may be defective.
	Appropriate input selector button is not pressed.	Press the appropriate input selector button corresponding to the input source.
	The SPEAKERS switches are not set properly.	Set the SPEAKERS switch that corresponds to the speakers to be used to the ON position.
	Speaker connections are not secure.	Secure the connections.
<b>The sound suddenly goes off.</b>	The protection circuit has been activated because of short circuit etc.	Turning the unit off and then on will reset the protection circuit.
<b>Only one side speaker outputs the sound.</b>	Incorrect setting of the BALANCE control.	Adjust it to the appropriate position.
	Incorrect cord connections.	Connect the cords properly. If the problem persists, the cords may be defective.
<b>There is a lack of bass, and no ambience.</b>	The + and – wires are connected in reverse at this unit or speakers.	Connect the speaker wires in the correct phase (+ and –).
<b>Sound “hums”.</b>	Incorrect cord connections.	Firmly connect the audio plugs. If the problem persists, the cords may be defective.
	No connection from the turntable to the GND terminal.	Make the GND connection between the turntable and this unit.
<b>Sound level is low.</b>	The LOUDNESS control is functioning.	Set the LOUDNESS control to the FLAT position.
<b>The input source cannot be changed, though any input selector button is pressed.</b>	The CD DIRECT AMP switch is ON.	Switch off the CD DIRECT AMP switch.
<b>Using the BASS, TREBLE, BALANCE and LOUDNESS controls does not affect the tone.</b>	The CD DIRECT AMP switch is ON.	The CD DIRECT AMP switch must be switched OFF to use those controls.
<b>The volume level is low while playing a record.</b>	The record is being played on a turntable with an MC cartridge.	The player should be connected to the unit through an MC head amplifier (available separately).
<b>The volume level cannot be increased, or sound is distorted.</b>	The power to the component connected to the REC OUT terminals of this unit is off.	Turn the power to the component on.
<b>The remote control transmitter does not work.</b>	Direct sunlight or lighting (of an inverter type of fluorescent lamp etc.) is striking the remote control sensor of the main unit.	Change the position of the main unit.
	The batteries of this remote control transmitter are too weak.	Replace the batteries with new ones.
<b>The sound is degraded when listening with the headphones connected to the compact disc player or cassette deck that are connected with this unit.</b>	The power to this unit is off.	Turn the power to this unit on.

# SPECIFICATIONS

## AUDIO SECTION

Minimum RMS Output Power per Channel  
8 ohms, 20 Hz to 20 kHz, 0.04% THD .....60W+60W  
6 ohms, 20 Hz to 20 kHz, 0.04% THD .....65W+65W

Maximum Output Power  
6 ohms, 1 kHz, 10% THD  
[General model only].....95W+95W

Dynamic Power per Channel  
(by IHF Dynamic Headroom measuring method)  
8/6/4/2 ohms.....80/95/115/125W

DIN Standard Output Power per Channel  
4 ohms, 1 kHz, 0.7% THD  
[Europe model only] .....90W

IEC Power  
8 ohms, 1 kHz, 0.04% THD  
[Europe model only] .....75W

Power Band Width  
8 ohms, 25W, 0.08% THD.....10 Hz to 40 kHz

Damping Factor  
8 ohms, 20 Hz to 20 kHz .....100 or more

Input Sensitivity/Impedance  
PHONO MM.....2.5 mV/47 k-ohms  
CD/TUNER/TAPE/AUX .....150 mV/47 k-ohms

Maximum Input Signal (1 kHz, 0.04% THD)  
PHONO MM .....90 mV

Output Level/Impedance  
REC OUT .....150 mV/0.6 k-ohms

Headphone Jack Rated Output/Impedance  
Output Level (8 ohms, 0.04% THD) .....0.42V  
Impedance .....390 ohms

Frequency Response (20 Hz to 20 kHz)  
CD/TUNER/TAPE/AUX .....0±0.5 dB

RIAA Equalization Deviation  
PHONO MM .....0±0.5 dB

Total Harmonic Distortion  
PHONO MM to REC OUT  
20 Hz to 20 kHz, 1V.....0.02%  
CD/TUNER/TAPE/AUX to SP OUT  
20 Hz to 20 kHz, 30W/8 ohms.....0.02%

Signal-to-Noise Ratio (IHF-A Network)  
PHONO MM to REC OUT  
(5 mV Input Shorted) .....82 dB  
CD/TUNER/TAPE/AUX to SP OUT  
(Input Shorted, CD DIRECT ON/OFF).....108 dB/102 dB

Residual Noise (IHF-A Network, CD DIRECT ON/OFF)  
.....50 µV/140 µV

Channel Separation (Vol. -30 dB)  
PHONO MM (Input Shorted, 1 kHz) .....65 dB  
CD/TUNER/TAPE/AUX  
(Input 5.1 k-ohms Terminated, 1 kHz).....60 dB

Tone Control Characteristics  
BASS: Boost/cut.....±10 dB (20 Hz)  
Turnover Frequency .....(350 Hz)  
TREBLE: Boost/cut .....±10 dB (20 kHz)  
Turnover Frequency .....(3.5 kHz)

Continuous Loudness Control .....- 30 dB (1 kHz)  
(Level related equalization)

## GENERAL

Power Supply  
[U.S.A. and Canada models].....AC 120V, 60 Hz  
[Europe and U.K. models].....AC 230V, 50 Hz  
[General model].....AC 110/120/220/240V, 50/60 Hz

Power Consumption  
[Europe model] .....130W  
[U.K. and General models] .....150W

AC Outlets  
3 SWITCHED OUTLETS  
[Europe and General models].....100W max. total  
1 SWITCHED OUTLET  
[U.K. model] .....100W max. total

Dimensions (W x H x D) .....435 x 146 x 309 mm

Weight .....7.3 kg

Accessories .....Remote control transmitter  
Batteries

Specifications are subject to change without notice.

# YAMAHA

---

YAMAHA ELECTRONICS CORPORATION, USA 6660 ORANGETHORPE AVE., BUENA PARK, CALIF. 90620, U.S.A.  
YAMAHA CANADA MUSIC LTD. 135 MILNER AVE., SCARBOROUGH, ONTARIO M1S 3R1, CANADA  
YAMAHA ELECTRONIK EUROPA G.m.b.H. SIEMENSSTR. 22-34, D-25462 RELLINGEN BEI HAMBURG, F.R. OF GERMANY  
YAMAHA ELECTRONIQUE FRANCE S.A. RUE AMBROISE CROIZAT BP70 CROISSY-BEAUBOURG 77312 MARNE-LA-VALLÉE CEDEX02, FRANCE  
YAMAHA ELECTRONICS (UK) LTD. YAMAHA HOUSE, 200 RICKMANSWORTH ROAD WATFORD, HERTS WD1 7JS, ENGLAND  
YAMAHA SCANDINAVIA A.B. J A WETTERGRENS GATA 1, BOX 30053, 400 43 VÄSTRA FRÖLUNDA, SWEDEN  
YAMAHA MUSIC AUSTRALIA PTY, LTD. 17-33 MARKET ST., SOUTH MELBOURNE, 3205 VIC., AUSTRALIA

YAMAHA CORPORATION  
VU27730